

**Industrial L2+ Multi-Port Full Gigabit
Managed Ethernet Switch**

IGS-5225-4T2S/IGS-5225-4P2S/IGS-5225-4UP1T2S

IGS-5225-8P4S/IGS-5225-8P4S-12V

IGS-5225-8P2T2S/IGS-5225-8P2T4S

Quick Installation Guide

Table of Contents

1. Package Contents.....	3
2. Requirements.....	5
3. Wiring the Power Inputs	6
3.1 Grounding the Device.....	8
4. Terminal Setup.....	9
4.1. Logging on to the Console.....	10
4.2 Configuring IP address	11
5. Starting Web Management	13
5.1 Logging in to the Industrial Managed Switch	13
5.2 Saving Configuration via Web	16
6. Recovering Back to Default Configuration	17
7. Customer Support	20

1. Package Contents

Thank you for purchasing PLANET L2+ Industrial Managed Switch, IGS-5225 Series. The number of the ports of these models is as follows:

	GbE Copper Ports	PoE Ports	GbE SFP Ports
IGS-5225-4T2S	4	-	1G/2.5G: 2
IGS-5225-4P2S	4	at/af: 4	2
IGS-5225-4UP1T2S	5	at/bt: 4	2
IGS-5225-8P4S	8	at/af: 8	1G: 2 1G/2.5G: 2
IGS-5225-8P4S-12V	8	at/af: 8	1G: 2 1G/2.5G: 2
IGS-5225-8P2T2S	10	at/af: 8	1G/2.5G: 2
IGS-5225-8P2T4S	10	at/af: 8	1G: 2 1G/2.5G: 2

“Industrial Managed Switch” mentioned in this Quick Installation Guide refers to the above models.

Open the box of the **Industrial Managed Switch** and carefully unpack it. The box should contain the following items for each model of the Industrial Managed Switch:

	The Industrial Managed Switch	Quick Installation Guide	Wall Mounting Kit	DB9 to RJ45, RS232 Console Cable	RJ45 Dust Cap	SFP Dust Cap
IGS-5225-4T2S	■	■	■	■	5	2
IGS-5225-4P2S	■	■	■	■	5	2
IGS-5225-4UP1T2S	■	■	■	■	6	2
IGS-5225-8P4S	■	■	■	■	9	4
IGS-5225-8P4S-12V	■	■	■	■	9	4
IGS-5225-8P2T2S	■	■	■	■	11	2
IGS-5225-8P2T4S	■	■	■	■	11	4

If any of these are missing or damaged, please contact your dealer immediately. If possible, retain the carton including the original packing materials to enable you to repack the product in case there is a need to return it to us for repair.

2. Requirements

The Industrial Managed Switch provides remote login interface for management purposes. The following equipment is necessary for further management:

- Workstations running Windows XP/2003/Vista/7/8/2008/10, MAC OS X or later, Linux, UNIX, or other platforms are compatible with TCP/IP Protocols.
- Workstations are installed with Ethernet NIC (Network Interface Card)
- Serial Port Connection (Terminal)
 - The above Workstations come with COM Port (DB9) or USB-to-RS232 converter.
 - The above Workstations have been installed with terminal emulator, such as Hyper Terminal included in Windows XP/2003, putty or tera term.
 - Serial cable -- one end is attached to the RS232 serial port, while the other end to the console port of the Industrial Managed Switch.
- Ethernet Port Connection
 - Network cables -- Use standard network (UTP) cables with RJ45 connectors.
 - The above PC is installed with Web browser.



Note

It is recommended to use Internet Explorer 8.0 or above to access the Industrial Managed Switch.

3. Wiring the Power Inputs

The Upper Panel of the **Industrial Managed Switch** comes with one 6-contact terminal block. Please follow the steps below to insert the power wire.

1. Insert positive/negative DC power wires into Contacts 1 and 2 for Power 1, or Contacts 5 and 6 for Power 2.

■ **IGS-5225-8P4S/IGS-5225-8P2T2S/IGS-5225-8P2T4S:** DC 48~56V

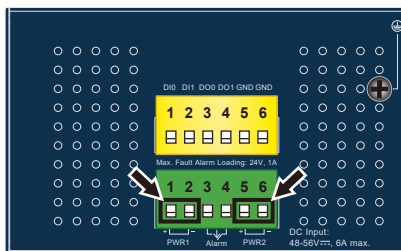

Figure 3-1: IGS-5225-8P4S/IGS-5225-8P2T2S/IGS-5225-8P2T4S Upper Panel

■ **IGS-5225-8P4S-12V:** DC 12~54V

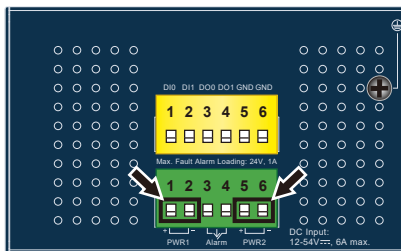

Figure 3-2: IGS-5225-8P4S-12V Upper Panel

■ **IGS-5225-4T2S:** DC 12~48V, AC 24V

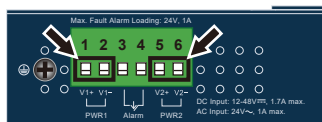

Figure 3-3: IGS-5225-4T2S Upper Panel

■ **IGS-5225-4P2S:** DC 48~56V

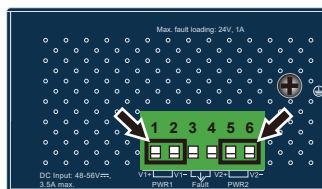

Figure 3-4: IGS-5225-4P2S Upper Panel

■ **IGS-5225-4UP1T2S:** DC 48~56V

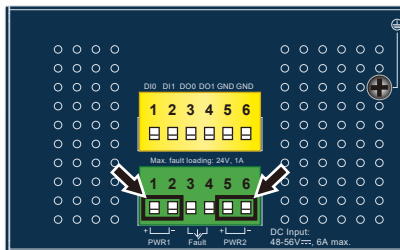
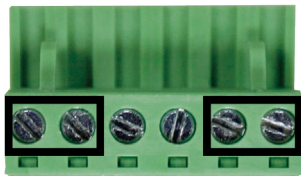

Figure 3-5: IGS-5225-4UP1T2S Upper Panel

2. Tighten the wire-clamp screws for preventing the wires from loosening.



1 2 3 4 5 6
 V+ V- V+ V-
 Power 1 Power 2

	Positive (+) Pin	Negative (-) Pin
IGS-5225 Series	Pin 1/5	Pin 2/6



Note

1. The wire gauge for the terminal block should be in the range from **12 to 24 AWG**.
2. Please check the wire AWG Ampere specification before connecting PLANET Industrial Managed Switch.



Caution

PWR1 and PWR2 must provide the **same DC voltage** for power load balance while operating with dual power input.

3.1 Grounding the Device

Users **MUST** complete grounding wired with the device; otherwise, a sudden lightning could cause fatal damage to the device.

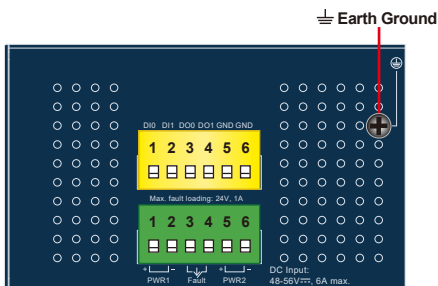

4. Terminal Setup

To configure the system, connect a serial cable to a **COM port** on a PC or notebook computer and to RJ45 type serial (console) port of the Industrial Managed Switch. The console port of the Industrial Managed Switch is DCE already, so that you can connect the console port directly through PC without the need of null modem.

IGS Industrial Managed Switch



PC/Workstation with Terminal Emulation Software



RJ45 to DB9 RS232 Cable

A terminal program is required to make the software connected to the IGS-5225 series Industrial Managed Switch.

1. Run terminal program on the OS.
2. When the following screen appears, make sure that the COM port should be configured as:

- Baud: 115200
- Parity: None
- Data bits: 8
- Stop bits: 1
- Flow control: None

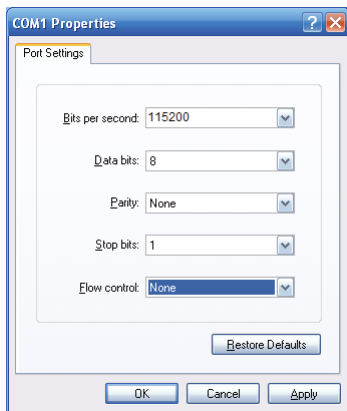

4.1. Logging on to the Console

Once the terminal has been connected to the device, power on the Industrial Managed Switch and the terminal will display “running testing procedures”.



Note

The following terminal configuration of the IGS-5225-4UP1T2S is taken for an example.

Then, the following message asks to log in user name and password. The default user name and password are shown as follows and the login screen in Figure 4-1 appears.

User name: **admin**

Password: **admin**

```
Now booting linux kernel:
Base address 0x80080000 Entry 0x80100000
Cmdline : init=/usr/bin/stage2-loader loglevel=4
Active fis: linux
[ 0.371610] mx35 spi0.3: NAND Flash Disable (Caracal)
00:00:00 Stage 1 booted
00:00:01 Loading stage2 from NOR flash partition 'linux'
00:00:10 Overall: 9792 ms, ubifs = 530 ms, rootfs 9236 ms of which xz = 0 ms of
which untar = 0 ms
00:00:21 Starting application...
Using existing mount point for /switch/

Press ENTER to get started

Username: █
```

Figure 4-1: Console Login Screen

The user can now enter commands to manage the Industrial Managed Switch. For a detailed description of the commands, please refer to the following chapters.



Note

1. For security reason, **please change and memorize the new password after this first setup.**
2. Only accept command in lowercase letter under console interface.

4.2 Configuring IP address

The Industrial Managed Switch is shipped with default IP address shown below:

```
IP Address: 192.168.0.100  
Subnet Mask: 255.255.255.0
```

To check the current IP address or modify a new IP address for the Switch, please use the procedure as follows:

■ Display of the current IP Address

1. At the “#” prompt, enter “**show ip interface brief**”.
2. The screen displays the current IP address shown in Figure 4-2.

```
Press ENTER to get started  
Username: admin  
Password:  
IGS-5225-4UP1T2S# show ip interface brief  
-----  
Interface Address Method Status  
-----  
VLAN 1 192.168.0.100/24 Manual UP  
IGS-5225-4UP1T2S#
```

Figure 4-2: IP Information Screen

■ Configuration of the IP Address

3. At the “#” prompt, enter the following command and press **<Enter>** as shown in Figure 4-3.

```
IGS-5225-4UP1T2S# configure terminal  
IGS-5225-4UP1T2S (config)# interface vlan 1  
IGS-5225-4UP1T2S (config-if-vlan)# ip address 192.168.1.100  
255.255.255.0
```

The previous command would apply the following settings for the Industrial Managed Switch.

```
IP Address: 192.168.1.100  
Subnet Mask: 255.255.255.0
```

```

Press ENTER to get started
Username: admin
Password:
IGS-5225-4UP1T2S# show ip interface brief
Interface Address Method Status
-----
VLAN 1 192.168.0.100/24 Manual UP
IGS-5225-4UP1T2S# configure terminal
IGS-5225-4UP1T2S(config)# interface vlan 1
IGS-5225-4UP1T2S(config-if-vlan)# ip address 192.168.1.100 255.255.255.0
IGS-5225-4UP1T2S(config-if-vlan)#

```

Figure 4-3: Configuring IP Address Screen

4. Repeat step 1 to check if the IP address has changed.

■ **Store the current switch configuration**

5. At the “#” prompt, enter the following command and press **<Enter>**.

copy running-config startup-config

```

Press ENTER to get started
Username: admin
Password:
IGS-5225-4UP1T2S# show ip interface brief
Interface Address Method Status
-----
VLAN 1 192.168.0.100/24 Manual UP
IGS-5225-4UP1T2S# configure terminal
IGS-5225-4UP1T2S(config)# interface vlan 1
IGS-5225-4UP1T2S(config-if-vlan)# ip address 192.168.1.100 255.255.255.0
IGS-5225-4UP1T2S(config-if-vlan)# exit
IGS-5225-4UP1T2S(config)# exit
IGS-5225-4UP1T2S# copy running-config startup-config
Building configuration...
do not reset or power off the device!
% Saving 2606 bytes to flash:startup-config
IGS-5225-4UP1T2S#

```

Figure 4-4: Saving Current Configuration Command Screen

If the IP is successfully configured, the Industrial Managed Switch will apply the new IP address setting immediately. You can access the Web interface of the Industrial Managed Switch through the new IP address.



Note

If you are not familiar with the console command or the related parameter, enter “**help**” anytime in console to get the help description.

5. Starting Web Management

The following shows how to start up the **Web Management** of the Industrial Managed Switch. Note the Industrial Managed Switch is configured through an Ethernet connection. Please make sure the manager PC must be set to the same **IP subnet address**.

For example, the default IP address of the Industrial Managed Switch is **192.168.0.100**, then the manager PC should be set to **192.168.0.x** (where x is a number between 1 and 254, except 100), and the default subnet mask is 255.255.255.0.

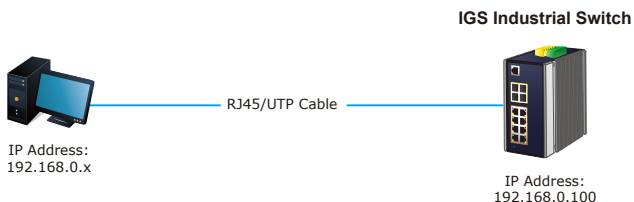

Figure 5-1: IP Management Diagram

5.1 Logging in to the Industrial Managed Switch

1. Use Internet Explorer 8.0 or above for Web browser and enter IP address **<https://192.168.0.100>** (the factory-default IP address) to access the Web interface.
2. When the following dialog box appears, please enter the default user name "**admin**" and password "**admin**" (or the password you have changed before) as shown in Figure 5-2.

Default IP Address: **192.168.0.100**

Default User Name: **admin**

Default Password: **admin**

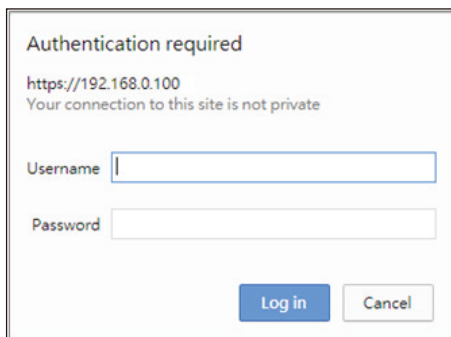

The image shows a web browser's authentication dialog box. At the top, it says "Authentication required" in blue. Below that, the URL "https://192.168.0.100" is displayed, followed by the warning "Your connection to this site is not private". There are two input fields: "Username" and "Password". At the bottom right, there are two buttons: "Log in" (in blue) and "Cancel" (in white).

Figure 5-2: Login Screen

3. After entering the password, the main screen appears as shown in Figure 5-3.



Figure 5-3: Web Main Screen of Industrial Managed Switch

The Industrial Managed Switch Menu on the top and left of the Web page lets you access all the functions and status the Industrial Managed Switch provides. The Switch Menu always contains one or more buttons, such as **"System"**, **"Switching"**, **"QoS"**, **"Security"**, **"PoE"**, **"Ring"**, **"ONVIF"** and **"Maintenance"**.



Figure 5-4: Switch Menu



Now, you can use the Web management interface to continue the Switch management. Please refer to the user manual for more.



If you are not familiar with Switch functions or the related parameter, press  **"Help icon"** like the following anytime on the Web page to get the help description.

5.2 Saving Configuration via Web

To save all applied changes and set the current configuration as a startup configuration, the startup-configuration file will be loaded automatically across a system reboot.

1. Click the **Save** icon on the top Switch Menu bar.



Figure 5-5: Save Config -- Hot Key

2. Press the **"Save Configuration"** button.

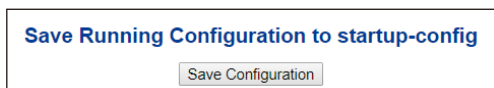

3. Or the other way to save the setting is to Click **Maintenance, Save Startup Config**.

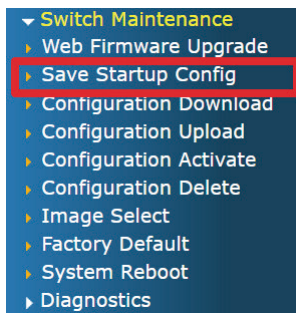

Figure 5-6: Save Config -- Maintenance

6. Recovering Back to Default Configuration

To reset the IP address to the default IP address “**192.168.0.100**” and the user password to factory default mode (default password is **admin**), press the hardware reset button on the front panel for about 10 seconds. After the device is rebooted, you can log in the management Web interface within the same subnet of 192.168.0.xx and default password. Be noted that all the previous setups will be disappeared after the factory default reset is made.

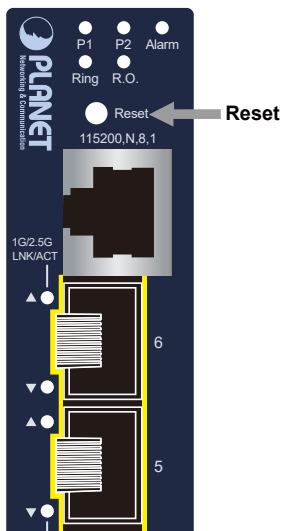

Figure 6-1: IGS-5225-4T2S Reset Button

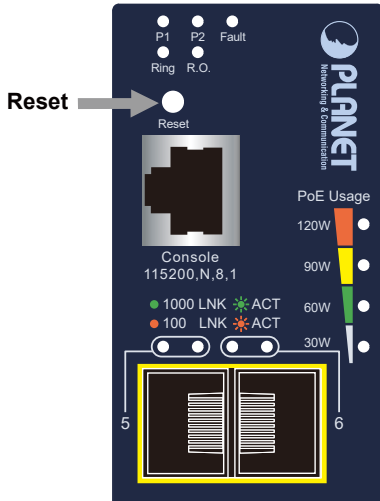

Figure 6-2: IGS-5225-4P2S Reset Button

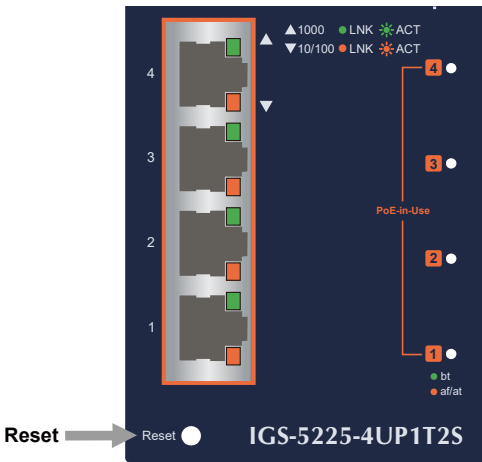

Figure 6-3: IGS-5225-4UP1T2S Reset Button

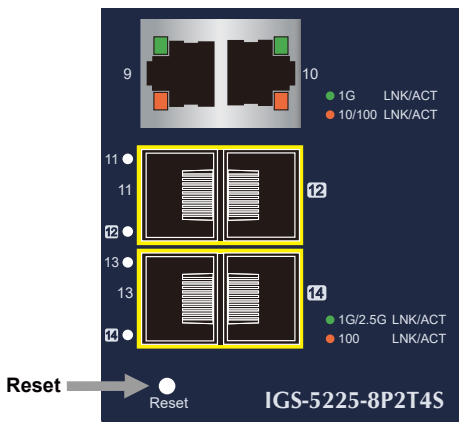

Figure 6-4: IGS-5225-8P4S/IGS-5225-8P4S-12V/IGS-5225-8P2T2S/
IGS-5225-8P2T4S Reset Button

7. Customer Support

Thank you for purchasing PLANET products. You can browse our online FAQ resource on PLANET web site first to check if it could solve your issue. If you need more support information, please contact PLANET switch support team.

PLANET online FAQs:

<http://www.planet.com.tw/en/support/faq>

Switch support team mail address:

support@planet.com.tw

IGS-5225-4T2S/IGS-5225-4P2S/ IGS-5225-8P2T4S/IGS-5225-8P4S/
IGS-5225-8P4S-12V/IGS-5225-8P2T2S/IGS-5225-4UP1T2S User's
Manual:

<https://www.planet.com.tw/en/support/downloads?&met-hod=keyword&keyword=IGS-5225&view=3#list>



(Please select your switch model name from the Product Model dropdown menu)

Copyright © PLANET Technology Corp. 2022.

Contents are subject to revision without prior notice.

PLANET is a registered trademark of PLANET Technology Corp.

All other trademarks belong to their respective owners.